

YAMAHA VMAX 1700

M O U N T I N G I N S T R U C T I O N S

REF 4952

WINDSHIELD NG SPORT



1 Person



20 min









EASY

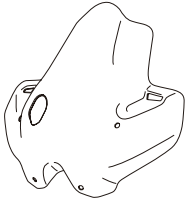

ALLEN

Nº 6
Nº 5
Nº 4

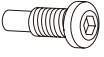

ID.	PIEZA/PART	DESCRIPCIÓN	DESCRIPTION	QTY.	REF.:
1		Cúpula Sport	Sport screen	1	4952F/N/H/WM3
2		Soporte derecho	Right support	1	SOPOR-2P-6-4952
3		Soporte izquierdo	Left support	1	SOPOR-2P-6-4952
4		Casquillo Ø8,5xØ14x3,5mm	Ø8,5xØ14x3,5mm arrowhead	2	CASQUI-----182
5		Tornillo inox M8x25 ISO7380	M8x25 ISO7380 Allen screw Inox.	2	TORNI-I7380-526
6		Tornillo allen M8x25 especial con mecha Ø6,2x8mm	M8x25 especial allen screw with cylinder ending Ø6,2x8mm	2	TORNI-I7380E525º
7		Silentblock M6	M6 silentblock	4	SILENBTM6-046/2
8		Arandela cónica de plástico Ø20mm	Ø20mm Conical plastic washer	4	ARANDENN20-030
9		Tornillo allen M6x22 DIN7991	M6x22 DIN7991 Allen screw	4	TORNI-D7991-427
10		Tapón tornillo M6 DIN7991	M6 DIN7991 screw cap	4	TAPON-----81

YAMAHA VMAX 1700

INSTRUCCIONES DE MONTAJE - MOUNTING INSTRUCTIONS - MONTAGEANLEITUNG

1

**DISASSEMBLY
DESMONTAJE**

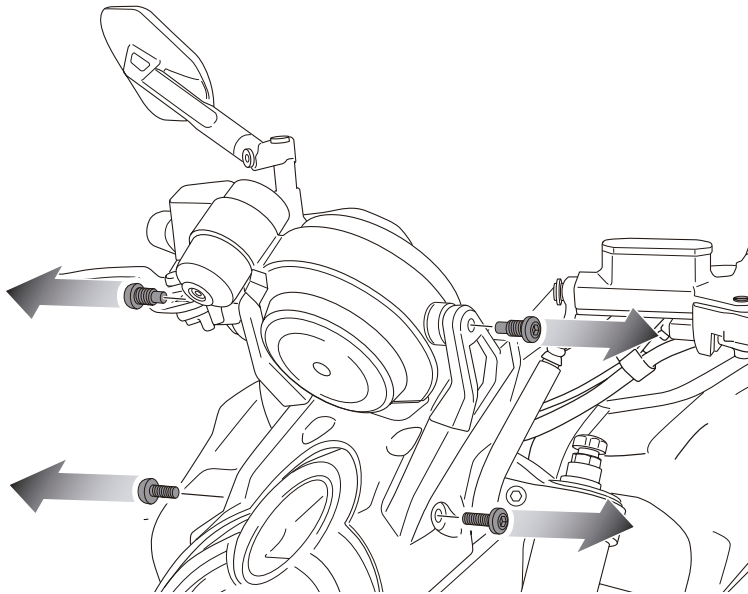

2

**ASSEMBLY
MONTAJE**

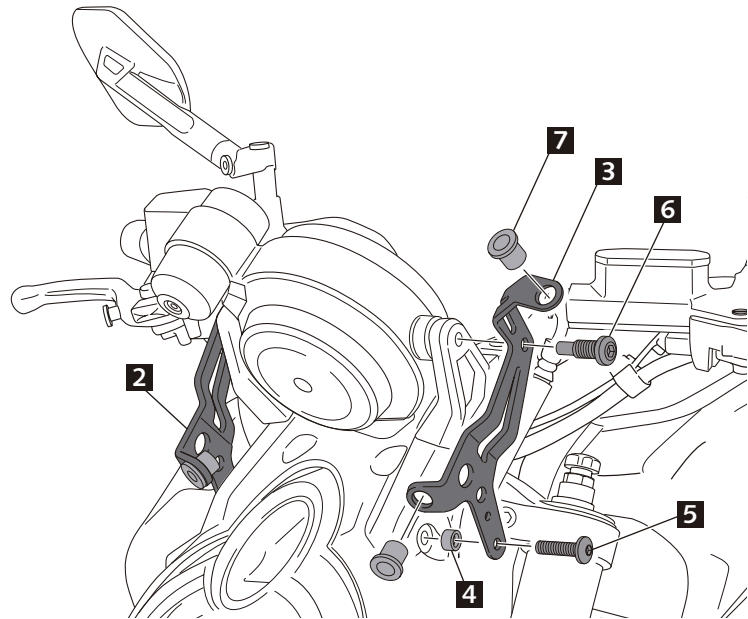

3

**ASSEMBLY
MONTAJE**

